

PARAMETERS	M2.3	M2.9	M3.4
Pixel Pitch:	2.31mm	2.97mm	3.47mm
Pixel Configuration:	Black SMD 1010	Black SMD 1515	Black SMD 2121
Brightness:	800 nit	1000 nit	1200 nit
Color Contrast :	6500:1	7500:1	7500:1
Refresh Rate:	≥3840 Hz	≥3840 Hz	≥3840 Hz
Gray Scale:	16384 level	16384 level	16384 level
Pixel Matrix per Cabinet :	216 × 216 Pixel	168 × 168 Pixel	144 × 144Pixel
Power Consumption (max/avg):	650/216 W/sq.m	440/150 W/sq.m	502/168 W/sq.m
Viewing Angle (H/V):	140°/100°	140°/120°	160°/140°
IP Rate:	IP40/IP21	IP40/IP21	IP40/IP21
Cabinet Size (W × H × D):	500 × 500 × 96 mm	500 × 500 × 96 mm	500 × 500 × 96 mm
Cabinet Weight:	8.3 kg	7.6 kg	7.6 kg
Cabinet material:	Die casting magnesium	Die casting magnesium	Die casting magnesium
Input Voltage (AC):	100 ~ 240 V	100 ~ 240 V	100 ~ 240 V
Operating Temperature:	-10 ~ +40 °C	-10 ~ +40 °C	-10 ~ +40 °C



M SERIES

M2.3/M2.9/M3.4

A REVOLUTIONARY NEW 2 MM RENTAL PRODUCT

★ Shenzhen Absen Optoelectronic Co., Ltd. reserves the right to modify product design, specifications, and parameters without further notice.
Photos are used for illustration purpose only as products may differ from these photos. All rights reserved by Shenzhen Absen Optoelectronic Co., Ltd.

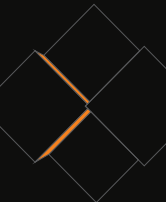

Shenzhen Absen Optoelectronic Co., Ltd.
18-20F Building 3A, Cloud Park, Bantian, Longgang District, Shenzhen 518129, P.R.China
T: +86-755-89747399 E: absen@absen.com
F: +86-755-89747599 W: www.absen.com

Absen Inc.
7120 Lake Ellenor Drive Orlando, Florida 32809, USA
T: +1-407-203-8870 E: info@usabsen.com
F: +1-407-203-8873 W: www.usabsen.com

Absen GmbH
Eisenstrasse 5, 65428 Russelsheim (Frankfurt), Germany
T: +49 (0) 6142 78935-0 E: europe@absen.com
F: +49 (0) 6142 78935-29 W: www.absen.com

LOCK AND ROLL



M2.9/M3.4 Contrast Ratio **7500:1**

M2.3 Contrast Ratio **6500:1**



M2.3 SMD 1010

VS

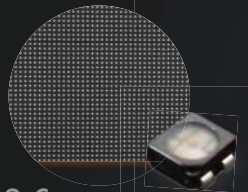

P2.6 SMD 2121

Perfect SMD size for 2.3mm pixel pitch delivering extreme blacks and high contrast –absolutely no competition when compared to a P2.6 with SMD 2121.

High Refresh Rate **3840 Hz**



M Series

VS



Others

- Refresh rate of 3840Hz.
- Excellent low brightness performance.



PERFECT DISPLAY PERFORMANCE

Eliminates scan lines (dark lines) and ghosting.
Moderates more ghosting effect on camera.

REVOLUTIONARY LOCKING SYSTEM

- Quick build times and perfect mechanical alignment, critical for 2mm rental products .
- Takes only 3 seconds to mount and lock.
- Flat to curves is simple and easy : no tools.

Magnetic Anti-Dust System



- Magnets on top enables easy installation

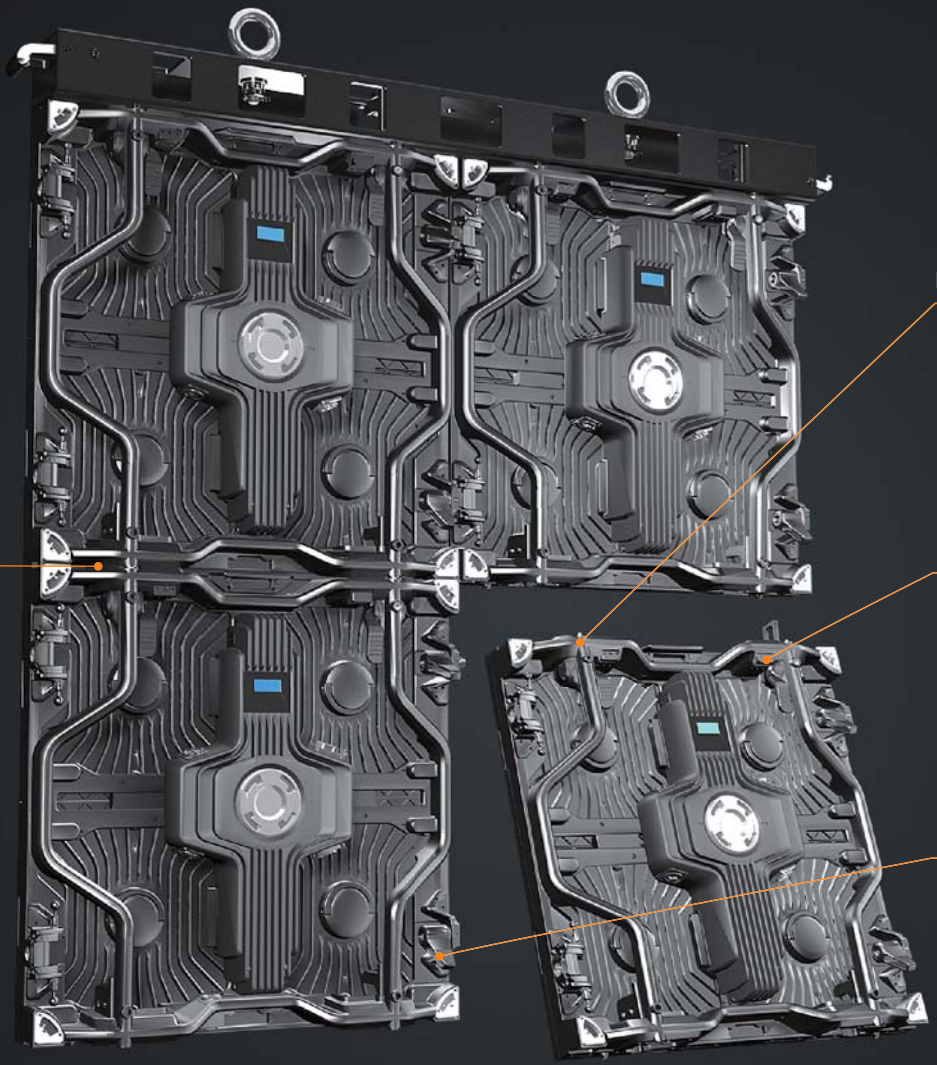

First:Vertical Clamper(Top Side)

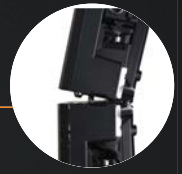

Second:Vertical Locking Handle

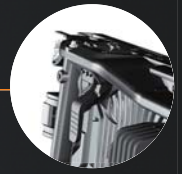

Last:Side Locking Hook & Curving Block



Detail



CURVE SYSTEM

- Supports both concave (inner) and convex (outer) curve screens for ultimate design flexibility.
- Unique locking system makes it simple to switch between flat or curved designs.
- Advanced locking system ensures curves are seamless without dark and light lines.
- Three-angle adjustment on the side locking system : Flat (0 °), concave (+5°), convex (-5 °).

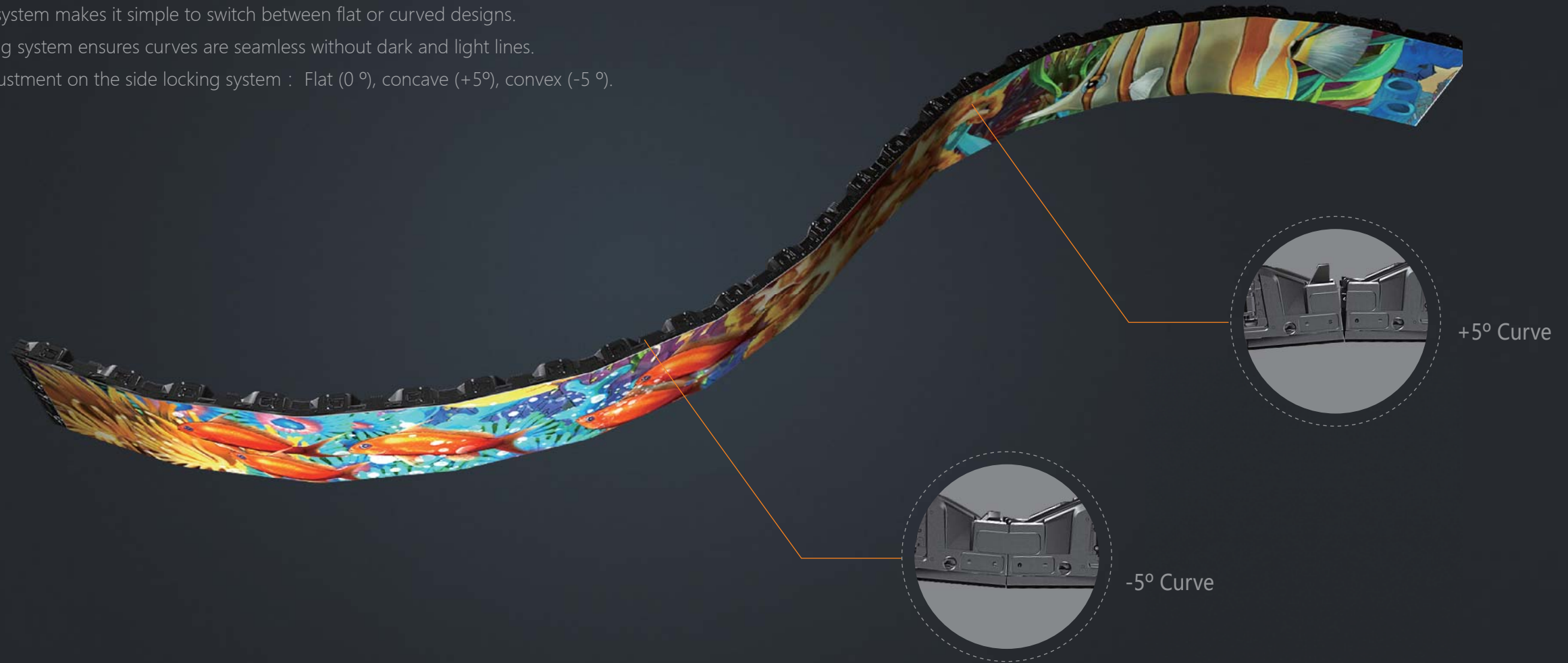

3 IN 1 DESIGN

- Lightweight and easy to handle.
- Change components without tools.
- Faster maintenance and repairs.

Front & Rear Module Maintenance



Push-then-Pull Modules (Magnetic Design)



Pull the Module from Rear (Magnetic Design)

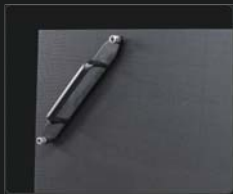

Connect Module Tool



Pull Module Off from Front

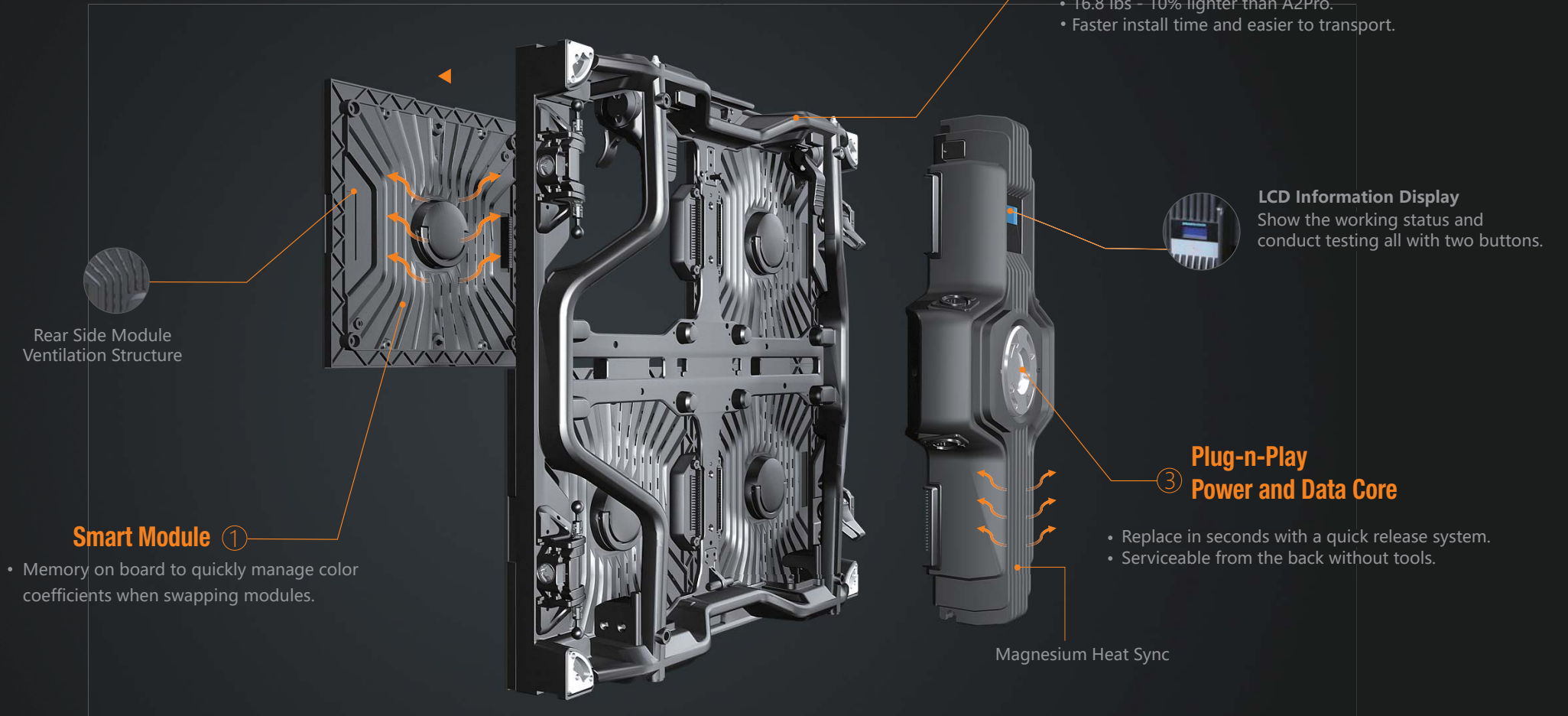

Drop, pop, and lock ground support for quick and easy floor installation.

ADVANCE HANGING AND STACKING SYSTEMS AVAILABLE

Strong, light weight, modular design for fast setup and easy transport

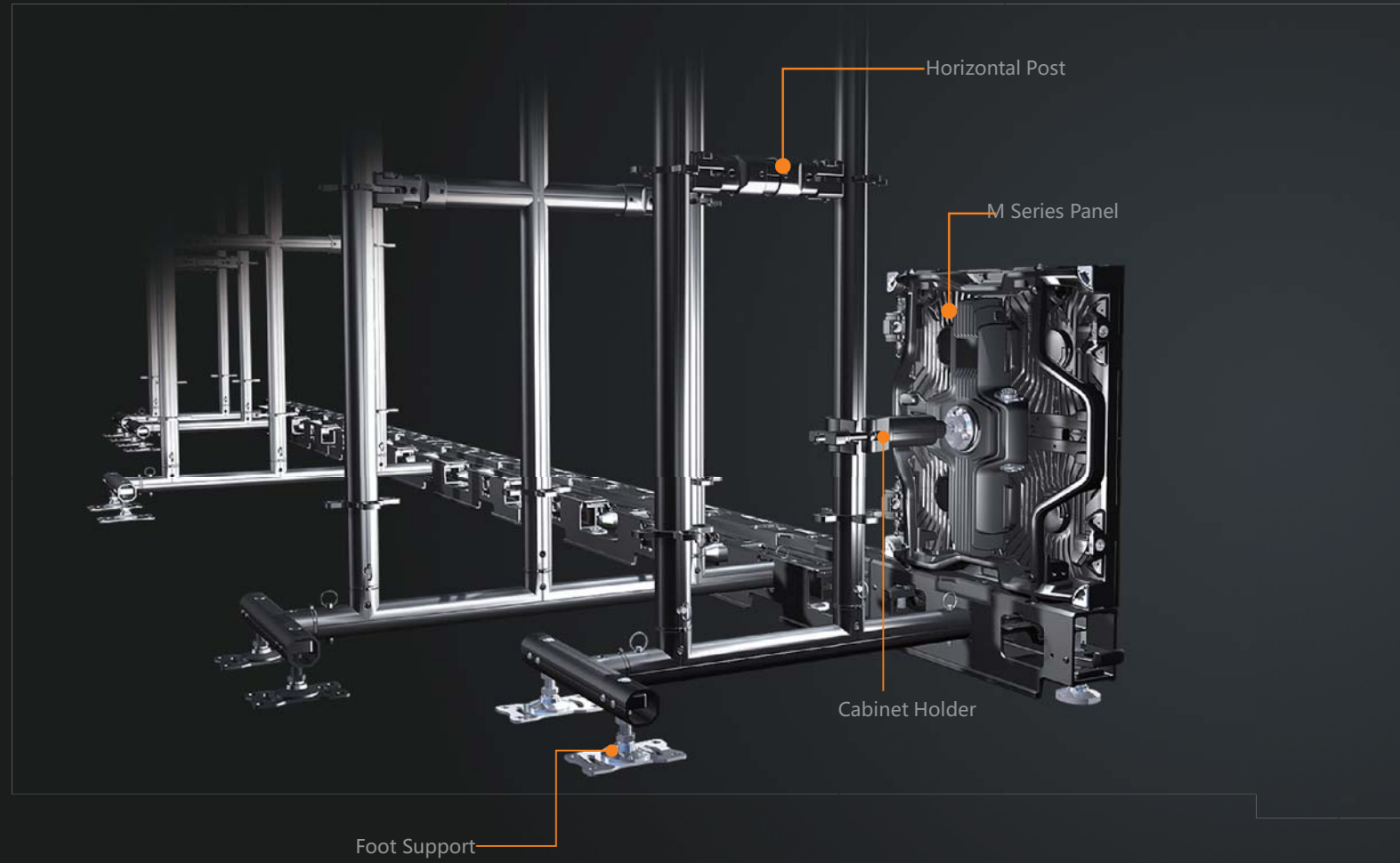

Eye Bolt Hanging Bar (Standard)

Clamp Type Hanging Bar (Optional)

Hanging Bar comes in two styles and four sizes.

- The road case protects your investment in storage or on the move .
- The angled shelves make insertion and removal easy while minimizing movement during travel.



10°

5 panel high design

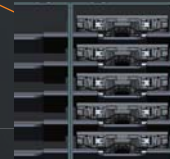

10 panels per case

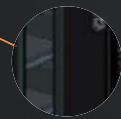

Window



A Type : 3*2 Flight Case

B Type : 2*2 Flight Case

96" x96" = 2,438(W)mm x 2,438(H)mm

Fits standard trucks

UNIQUE SIDE-LOADING FLIGHT CASE

LED panels stored horizontally to prevent SMD damage.

Flight cases are optimised to fit in vehicles for low cost transport.

Fully stackable to save space.